



บริษัท แหน็ค ส. เจริญกิจ จำกัด
KNACK S. CHAREONKIJ CO.,LTD.

FLOOR DRAIN

MODEL : 401 S (สำหรับท่อ PVC ขนาด 2"-4")

ISO 9001

BUREAU VERITAS
Certification

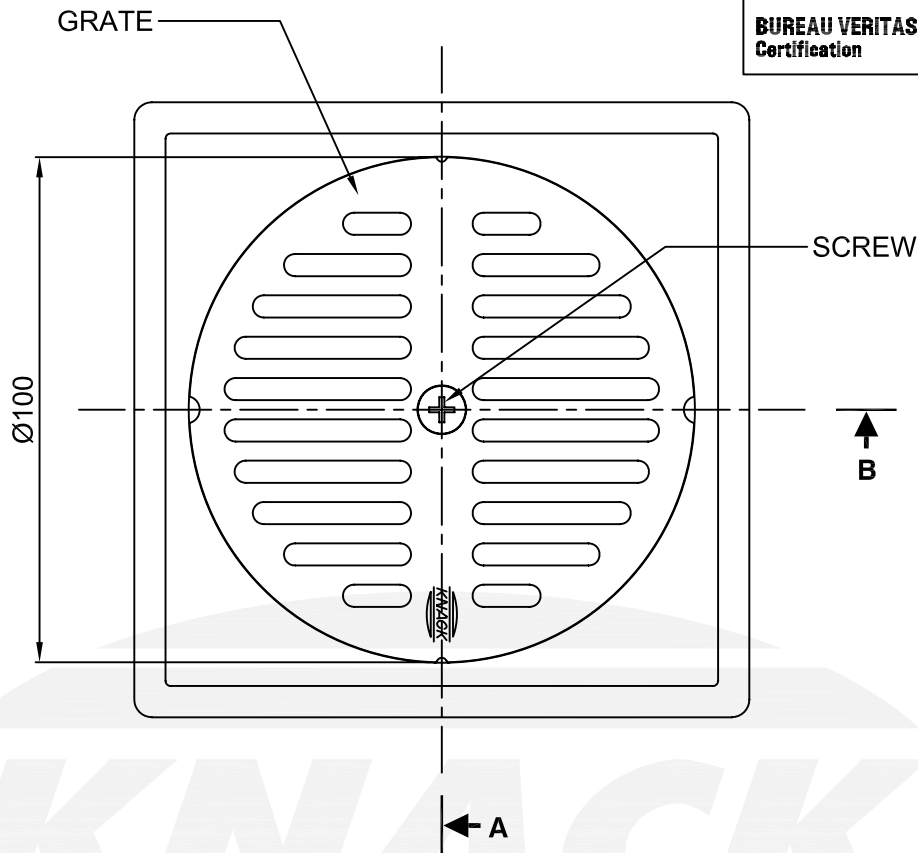

TOP VIEW

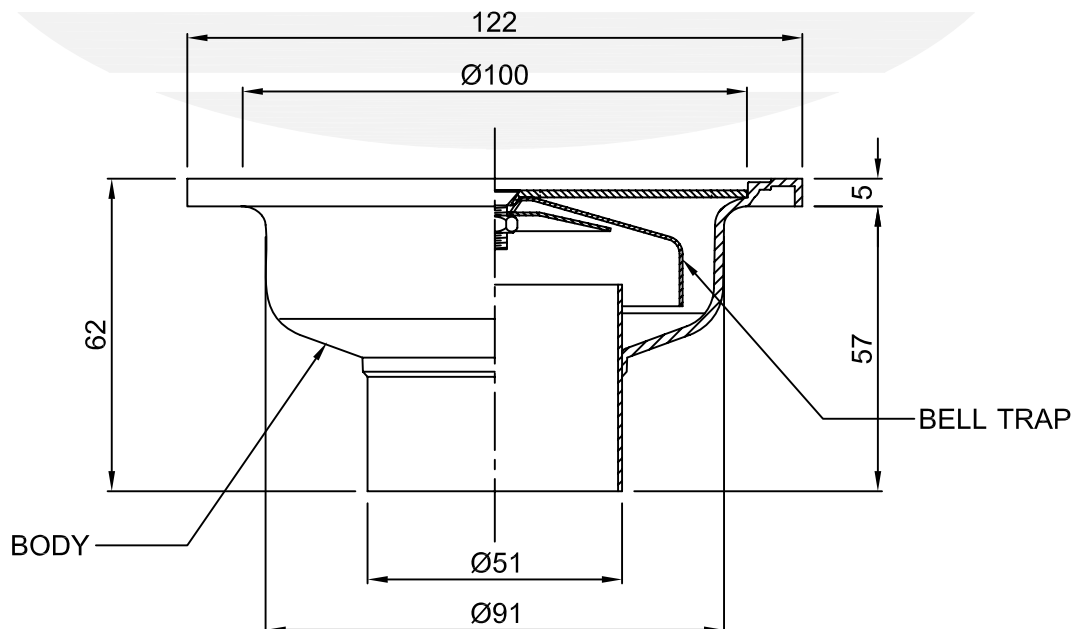

SECTION A - B

CUSTOMER		N/A				PROJECT		N/A	
DRAWN	CH.WORAWIT	DATE	2 / 07 / 57	REV.	01	RANGE (MM.)		TOLERANCES CHECK	
DWG.No.	0207571-D1	WORKTYPE	MTO	SCALE	1 : 1.5			CASTING (MM.)	MACHING (MM.)
DIMENSION IN MM.						0 - 99	± 1	± 0.5	
MATERIAL						100 - 149	± 2	± 0.8	
STAINLESS STEEL GRADE 18-8						150 - 499	± 3	± 1	
FINISHING						500 - 999	± 6	± 2	
-						1000 - UPPER	± 8	± 3	