

ISO 9001

BUREAU VERITAS
Certification

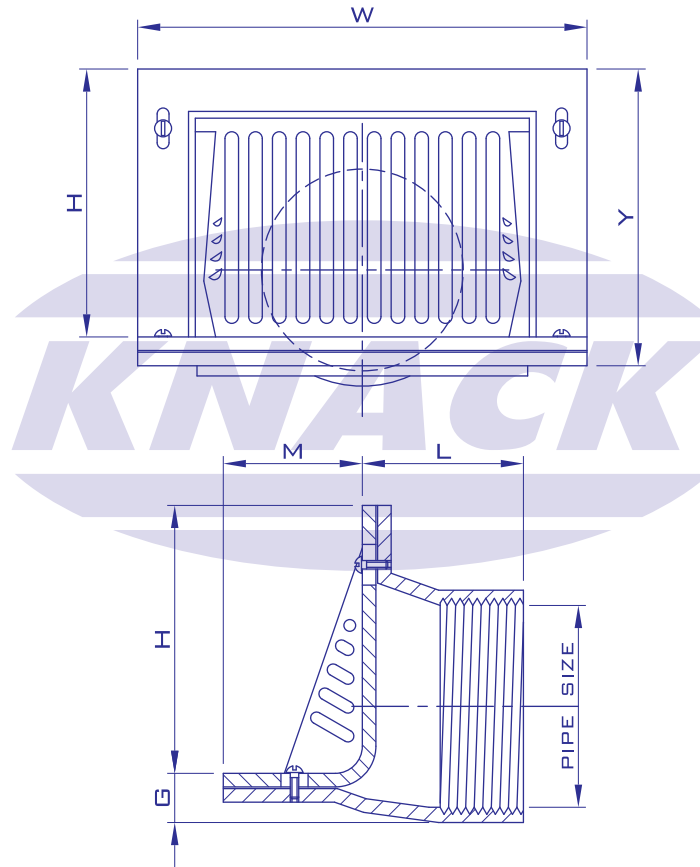

SCUPPER DRAIN

MODEL 621

Pipe Size Inch	G	H	L	M	W	Y	Free Area (mm. ²)
2	25	148	75	104	270	170	8550
2 1/2	25	148	75	104	270	170	8550
3	25	148	75	104	270	170	8550
4	25	148	75	104	270	170	8550
5	30	190	98	110	320	218	18000
6	30	190	98	110	320	218	18000
8	34	190	113	110	320	218	18000

