

ISO 9001

BUREAU VERITAS
Certification

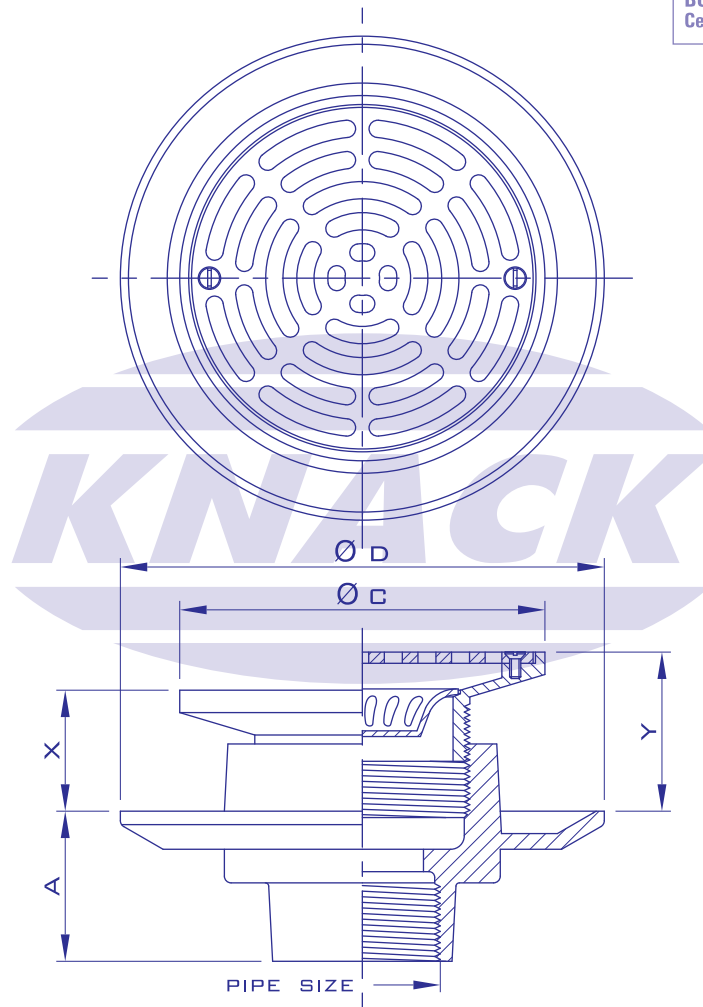

FLOOR DRAIN

MODEL 230 P

ADJUSTABLE STRAINER

Pipe Size Inch	A	C	D	Adjustment		Free Area (mm. ²)
				X	Y	
1 1/2	63	120	195	46	61	2400
2	63	120	195	46	61	2400
2 1/2	63	120	195	46	61	2400
3	63	120	195	46	61	2400
4	65	165	220	41	65	6500

